

SUMMIT

(OUTSWING AND INSWING)

IMPACT ENTRANCES

IMPACT ENTRANCES

CONTENTS

PAGE

GENERAL INSTALLATION NOTES	3
FEATURES	4
PARTS IDENTIFICATION	5 - 6
SECTION DIMENSION	7
TYPICAL OUTSWING DOOR DETAILS	8 - 9
TYPICAL INSWING DOOR DETAILS	10 - 11
ENTRANCE PACKAGE	12 - 13
DOOR FRAME ASSEMBLY	14
DOOR LEAF ASSEMBLY (STANDARD)	15
DOOR LEAF ASSEMBLY (HEAVY DUTY)	16
DOOR FRAME INSTALLATION	17
DOOR LEAF HANGING	18

IMPACT ENTRANCES

GENERAL INSTALLATION NOTES

1. **Safety-** Safety should be the primary concern throughout the installation process. Keep the installation areas clear of debris and obstructions. Lift and carry products carefully using proper lifting procedures. Always wear safety gear as determined by products and or jobsite conditions.
2. **Building Code-** The Building Code determines the requirements of products to be used on a project. Aldora manufactures products to the installer's specifications; however, Aldora does not assume any responsibility for the suitability of its products for any project. It is the responsibility of the glazier to ensure each product meets the project requirements.
3. **Openings-** Measure the openings to determine if they match the building plans. Notify the General Contractor immediately to correct any deviation.
4. **Shop drawings-** Review shop drawings to ensure all materials have been manufactured in accordance with the shop drawings.
5. **Receiving-** Inspect all products upon receipt. Do not install any damaged or deficient products. Return to Aldora immediately for correction.
6. **Protection-** Protect all materials from damage including cement, stucco, paint, mud or other abrasives or chemicals. Materials need to be protected properly before, during and after installation.
7. **Field testing-** Glaziers must fully understand all sealing procedures in advance of installation. If installed correctly and properly sealed, Aldora's products will achieve satisfactory results during field test. Aldora will not accept any responsibility for installation deficiencies.

Pre-installation

1. **Checklist-** Working from a checklist, bring all necessary documents, tools, equipment and supplies to the jobsite.
2. **Products-** Review all products versus the shop drawings to ensure everything is at the jobsite. Examine mark numbers to verify proper products per opening.
3. **Anchors-** Verify anchors supplied match shop drawings.
4. **Opening preparation-** Clean opening of all debris and examine for level and plumb.
5. **Aluminum surfaces in contact with lime-mortar, concrete or other masonry materials, shall be protected with alkali-resistant coating.**

Note: Perimeter sealing of the product to the substrate is not covered under this document. Please refer to the product's notice of acceptance or Florida building code approval for specifics. All perimeter caulking and waterproofing should comply with the above mentioned documents and sealant compatibility and performance should be designed for specific job conditions. Failure to have an adequate barrier will lead to water intrusion.

FEATURES:















- SUMMIT A MEDIUM STILE DOOR
- OUTSWING AND INSWING DOORS
- DOOR FRAME PROFILE IS 1 3/4" X 4 1/2"
- UP TO 8'-0" X 10'-0" PAIRS
- 2010 ENERGY CODE COMPLIANT
- PANIC EQUIPPED WITH ADAMS RITE OR SARGENT- CAN BE ELECTRIFIED (OUTSWING DOOR ONLY)
- PANIC EQUIPPED WITH VON DUPRIN AND REGENT TO 8'- CAN BE ELECTRIFIED (OUTSWING DOOR ONLY)
- OPTIONAL CONTINUOUS GEAR HINGES
- 3/8" Ø TIE ROD ASSEMBLY (STANDARD)
- 3/8" Ø TIE ROD ASSEMBLY AND CORNER KEY ASSEMBLY (HEAVY DUTY)
- 9/16" LAMINATED OR 1 5/16" LAMINATED-INSULATED GLASS
- ADA BUMPER THRESHOLD
- OPTIONAL 3/4" JAMBS- AT CURTAIN WALL APPLICATIONS (TO AVOID A BULKY ALUMINUM WHEN INSERT A DOOR AT CURTAIN WALL SYSTEM)
- OPTIONAL 10" BOTTOM RAIL FOR ADA
- EXTERIOR WEATHERSEAL GLAZING
- ANODIZED AND PAINTED FINISHES STANDARD











OPTIONS:

- MULTIPLE PANICS (AT OUTSWING DOORS ONLY)
- INSULATED LAMINATED GLAZING
- RESIDENTIAL 3 POINT LATCH LEVEL
- BUTT HINGES OR CONTINUOUS GEAR HINGE
- 10" BOTTOM RAIL
- HIGH RISE THRESHOLD (AT OUTSWING DOORS ONLY)
- ASTRAGALS AT MEETING STILE WHEN WATER RATING IS NEEDED (AT OUTSWING DOORS ONLY)

SUMMIT IMPACT ENTRANCES

PARTS IDENTIFICATION











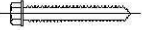

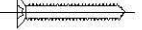

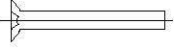





PROFILE	PART #	DESCRIPTION
	SMI-004	PLAIN SNAP
	SMI-005	STANDARD FRAME JAMB
	SMI-006	FRAME HEAD
	SMI-008	DOOR SASH STOP
	SMI-009	MEETING STILE
	SMI-011	HINGE STILE
	SMI-012	TOP RAIL
	SMI-013	BOTTOM RAIL
	SMI-015	DOOR STOP COVER
	SMI-036	BUMPER THRESHOLD BASE
	SMI-037	THRESHOLD RAMP ADAPTER
	SMI-038	ADA THRESHOLD COVER
	SMI-039	HI-RISE THRESHOLD COVER
	SMI-043	NARROW FRAME JAMB

PROFILE	PART #	DESCRIPTION
	SMI-044	DOOR STOP BASE
	SMI-051	DOOR STILE REINF.
	SMI-058	ASTRAGAL
	SMI-065	10" BOTTOM RAIL
	SMI-066	MEDIUM -RISE THRESHOLD COVER
	SMI-070	FEMALE CORNER KEY & REINF.
	SMI-071	MALE CORNER KEY & REINF.
	SMI-092	GLASS STOP
	SMI-096	DOOR SASH BASE
	SMI-097	DOOR SASH STOP
	SMI-PW001	PICTURE WINDOW @ TRANSOM

IMPACT ENTRANCES

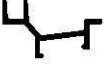
SUMMIT IMPACT ENTRANCES

PARTS IDENTIFICATION (Continued)

PROFILE	PART #	DESCRIPTION	PROFILE	PART #	DESCRIPTION
	SMI-G01	INTERIOR GLAZING GASKET			ASSEMBLY SCREW #12 X 1 1/2" LG. HX. WASHER SMS. ST/ST
	SMI-G07	SPACER/ OUTER GASKET			ASSEMBLY SCREW #12 X 1 1/2" LG. FT. HD. SMS. ST/ST
	SMI-B01	BULB			MULLION SCREW 1/4-20 X 2 1/4" LG. FT. HD. MACHINE BOLT ST/ST
	SMI-W01	WOOL PILE			NUTS 1/4-20 HEX. ST/ST
	SMI-SB03	SETTING BLOCK 1/4" X 3/8" X 4" LG.			3/8" Ø - 16 X 1" LG. SOCKET CAP SCREW
	SMI-SB04	SETTING BLOCK 3/8" X 1 1/4" X 4" LG.			3/8" Ø TIE ROD ASSEMBLY W/ NUT & ROUND WASHER
	SMI-SB05	SETTING BLOCK 1/4" X 1 3/16" X 4" LG.			1 1/2" X 2" X 1/8" THK. RECTANGULAR ALUMINUM PLATE.
	SMI-SB06	SETTING BLOCK 3/8" X 5/8" X 4" LG.			
	SMI-G11	SINGLE FACE FOAM TAPE 1/8" X 1/2"			
	SMI-G12	DOUBLE FACE FOAM TAPE 3/16" X 1/2"		ST-1a	VERTICAL STEEL REINFORCEMENT
	SMI-P03	TEMPORARY GLASS STOP		ST-2a	VERTICAL GALVANIZED REINFORCEMENT
	SMI-P08	TEMPORARY GLASS STOP		ST-1c	HORIZONTAL STEEL REINFORCEMENT

IMPACT ENTRANCES

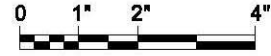

SUMMIT MEDIUM STILE DOOR

STANDARD LOCATIONS
(3 POINT LOCK W/ PUSH BAR & PULL HANDLE AT OUTSWING & INSWING DOORS)

STANDARD LOCATIONS
(PANICS & PULL HANDLE AT OUTSWING DOORS ONLY)

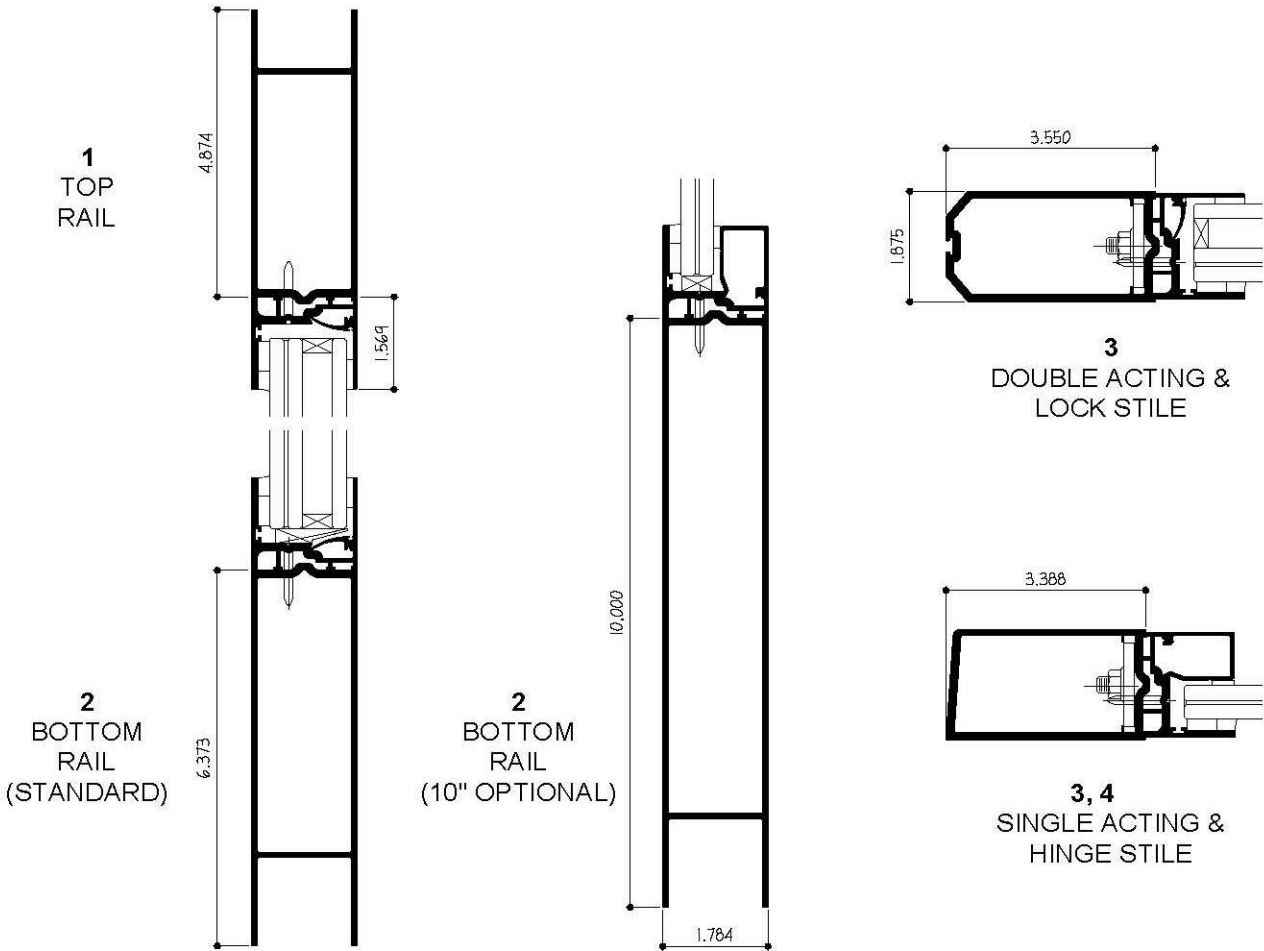
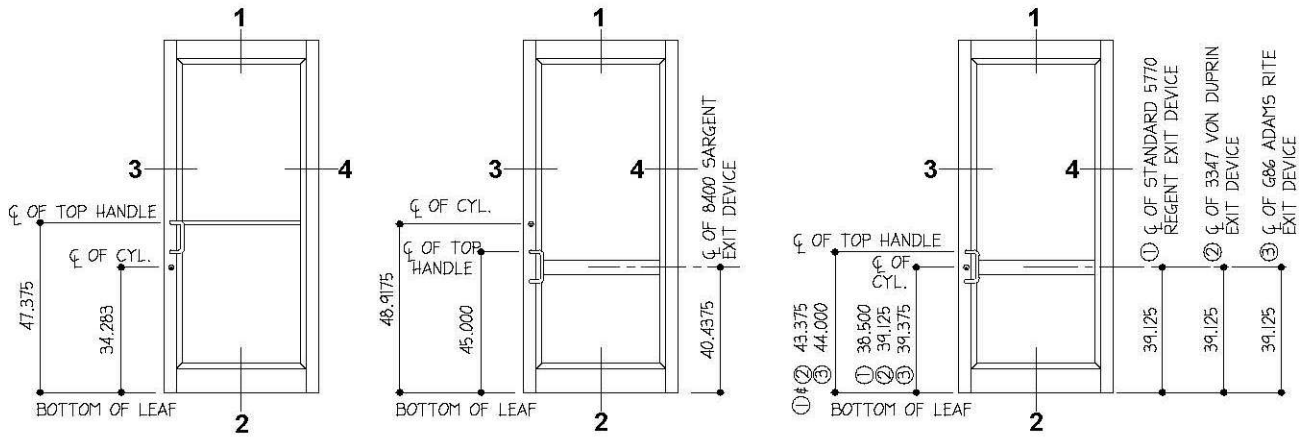

IMPACT ENTRANCES

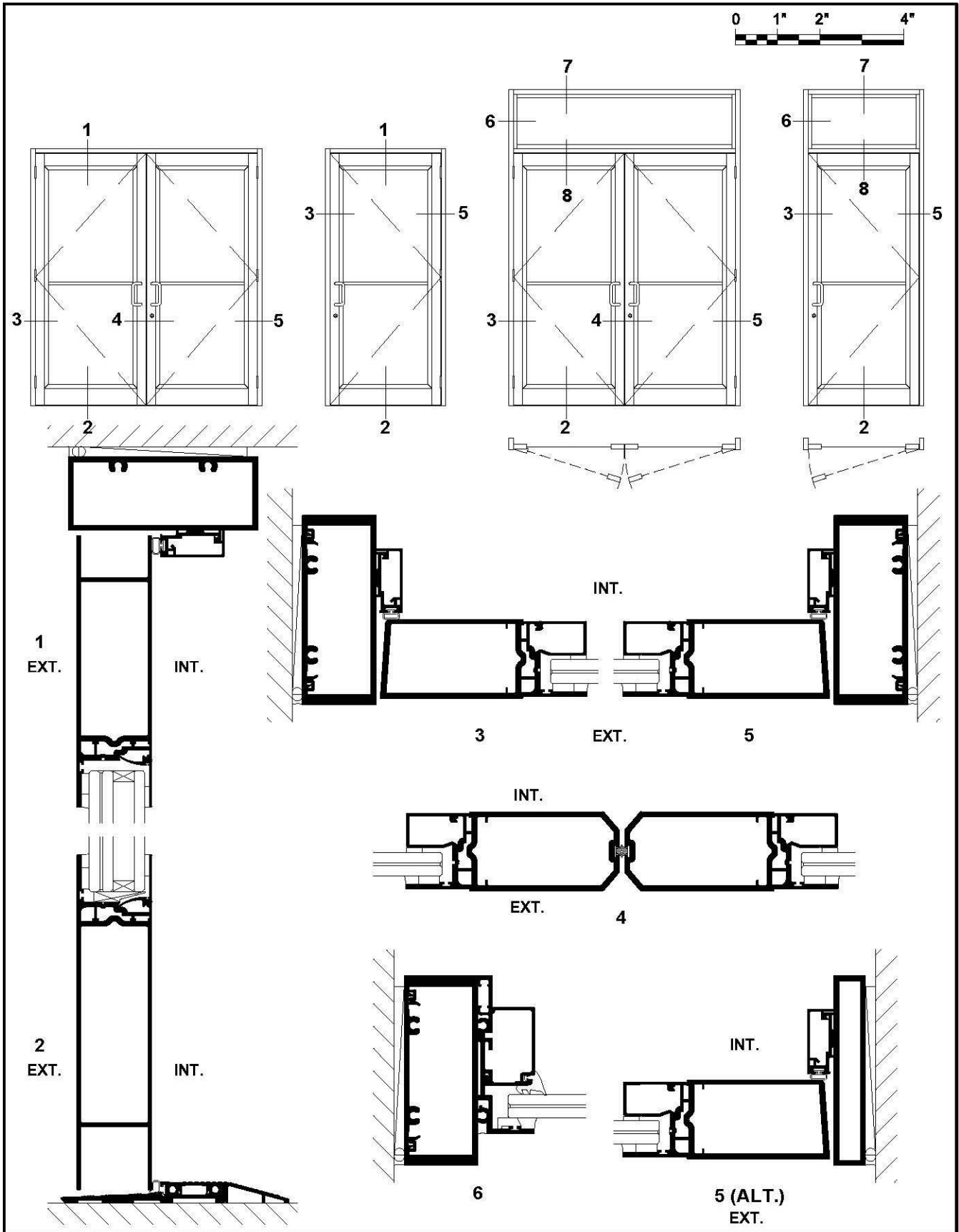

IMPACT ENTRANCES

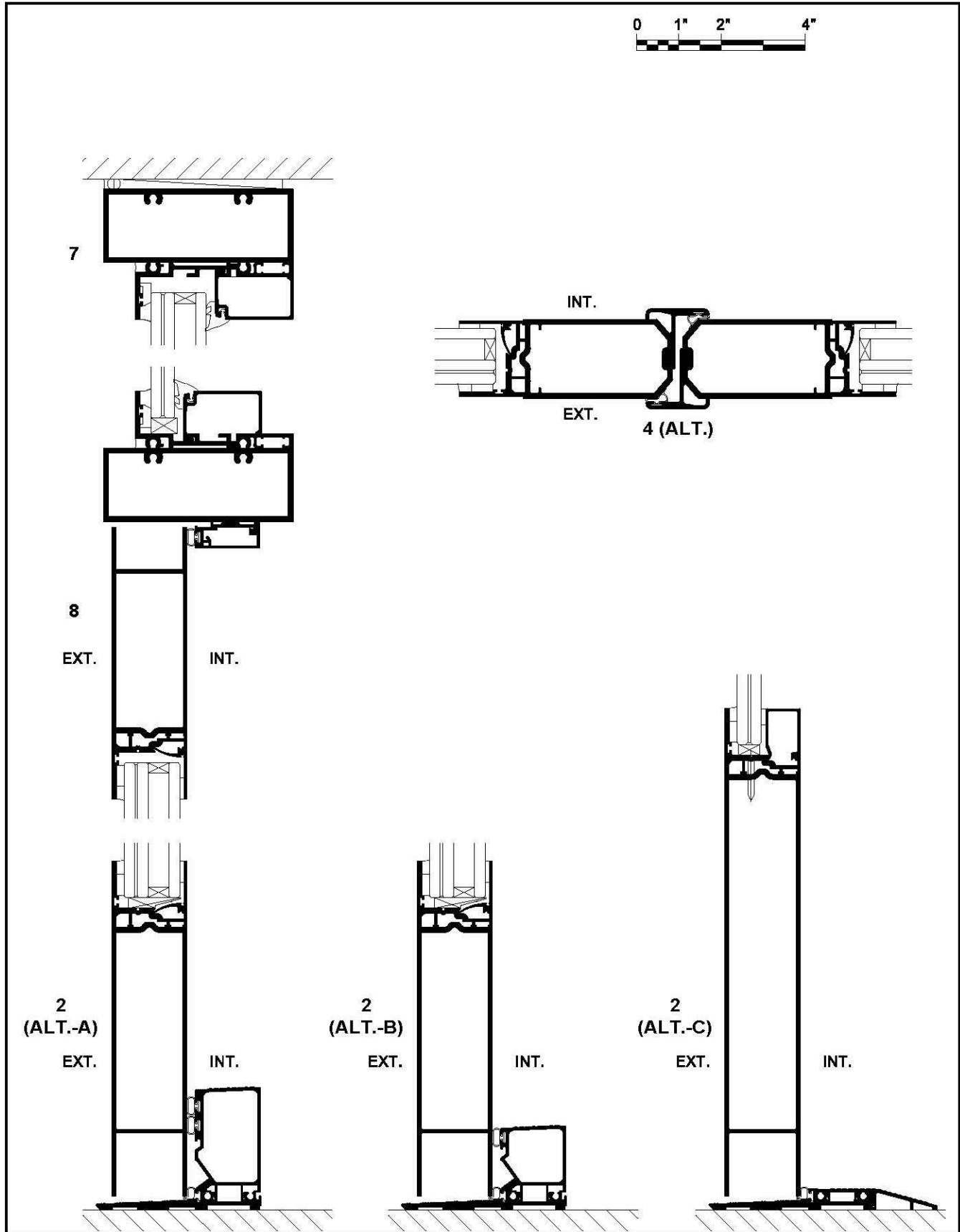

IMPACT ENTRANCES

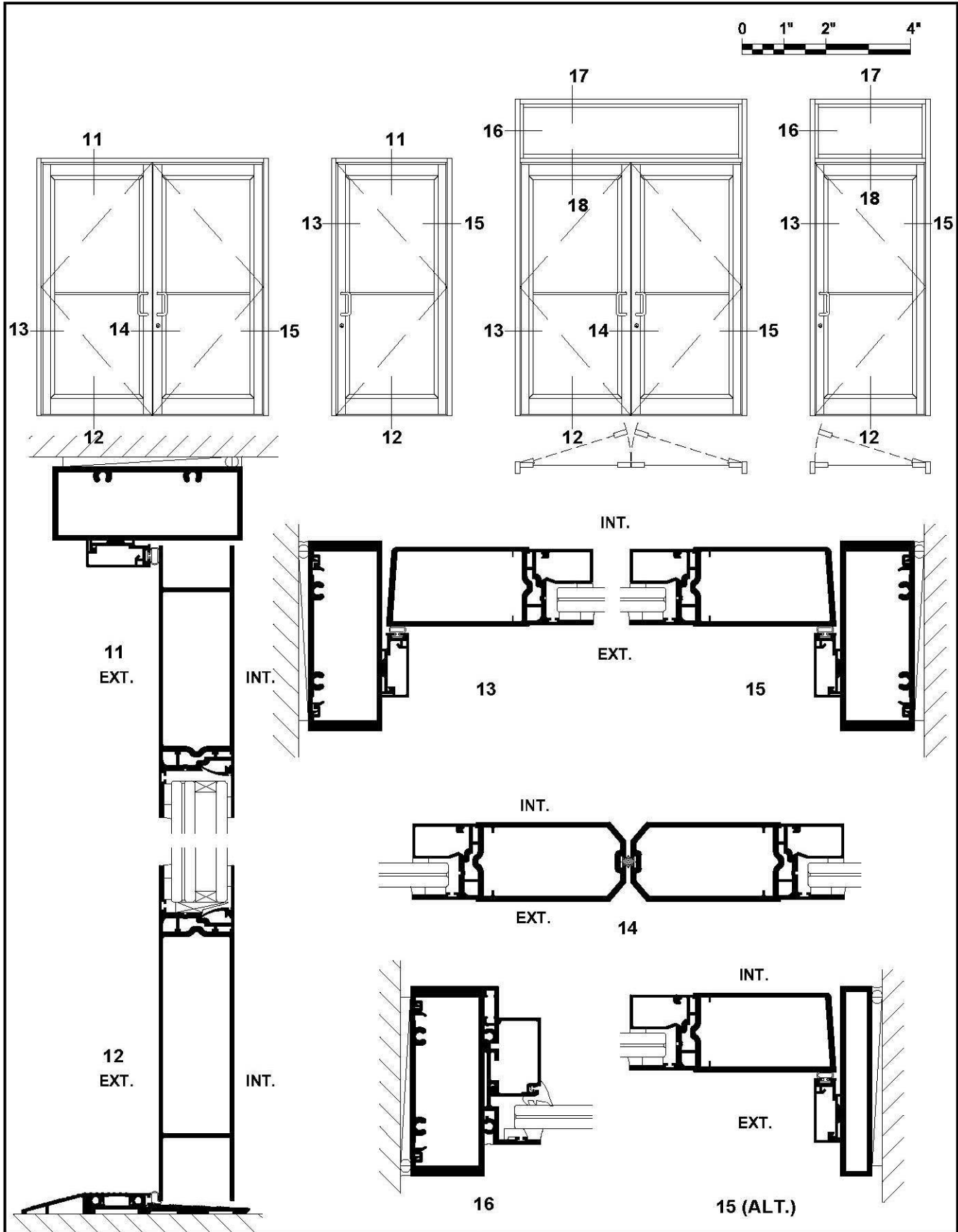

IMPACT ENTRANCES

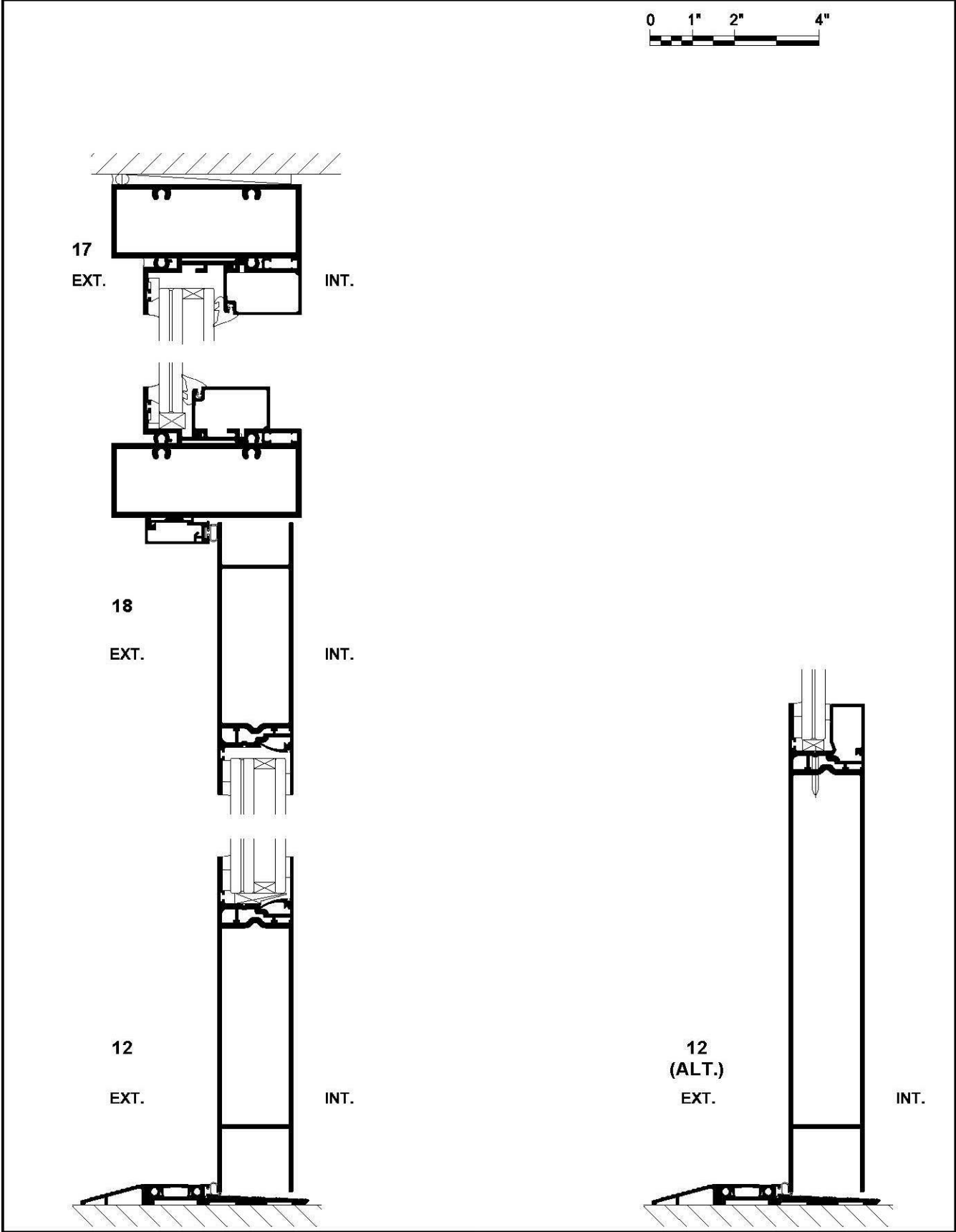

IMPACT ENTRANCES

SPECS/ HARDWARE	STANDARD	OPTIONAL
DOOR SIZE	ANY STANDARD SIZE.	ANY SIZE UP TO 8'-0" X 10'-0" PAIRS W/O TRANSOM & 8'-0" X 12'-0" PAIRS WITH TRANSOM.
DOOR FRAME	1 3/4" X 4 1/2" TYP. DOOR FRAMING.	3/4" X 4 1/2" NARROW FRAMING.
PUSH-PULLS	ARCHITECT CLASSIC HARDWARE SFD 5010-10" CTC PULL AND SFD 5033 PUSH BAR. SFD 5010-10" CTC BACK TO BACK.	ANY CUSTOM PUSH AND PULLS THAT FIT IN STILES & DO NOT INTERFERE WITH THE DOOR HARDWARE MECHANISM OR AFFECT PRODUCT APPROVAL.
LOCKS - ACTIVE LEAF	REGENT- 3 POINT HOOKBOLT MORTISE LOCK SERIES 2002H.	REGENT- RESIDENTIAL LATCH LEVER 3 POINT LOCK SERIES ML-207-012-03.
LOCKS - INACTIVE LEAF	ADAMS RITE- 2 POINT LOCK SERIES MS1880.	REGENT- RESIDENTIAL LATCH LEVER 2 POINT LOCK SERIES M-207-TT-2-PT.
THRESHOLD	3 9/16" X 1/2" HT. ADA ALUMINUM MILL FINISH BUMPER THRESHOLD BASE.	-COVERS TO MEET ADA W/INTERIOR RAMP (BUT NOT WATER RESISTANT APPROVED) -MEDIUM-RISE COVER (2" HT. & WATER RESISTANT APPROVED). -HI-RISE COVER (3" HT. & WATER RESISTANT APPROVED).
HINGES	REGENT- BUTT HINGES SERIES 4001- 4" X 4 1/2"	IVES- CONTINUOUS ALUMINUM GEARED HINGE, SERIES 27G5. PEMKO- CONTINUOUS ALUMINUM GEARED HINGE, SERIES FM SLI. HAGER- CONTINUOUS ALUMINUM GEARED HINGE, SERIES 780-112.
DOOR CLOSER	O.H.C.C: -REGENT, CL3031-ADJ 105° W/O HOLD OPEN (MEDIUM DUTY). SURFACE MOUNTED: -REGENT, CL 3084 (STANDARD DUTY). -REGENT, CL 3870 (MEDIUM DUTY). -REGENT, CL 4500 (HEAVY DUTY).	O.H.C.C: -LCN, 2034. SURFACE MOUNTED: -LCN, 4041.

SPECS/ HARDWARE	STANDARD	OPTIONAL
EXIT DEVICE	-REGENT 5770, EXIT DEVICE. -REGENT 5770 ELE., ELECTRICAL EXIT DEVICE.	-VON DUPRIN 3347A. -VON DUPRIN EL3347A (ELECTRICAL). -SARGENT 8410, -SARGENT 56-8410 (ELECTRICAL). -ADAMS RITE G86.
POWER SUPPLY	-REGENT 1406-04-AO.	-VON DUPRIN PS-914. -SARGENT 3547.
POWER TRANSFER	-REGENT 4001-8 ELECTRICAL HINGE.	-HAGER BB1191 ETW8 ELECT. HINGE. -VON DUPRIN EPT10. -McKINNEY T4A3386 X QC-C 4 1/2" X 4" ELECT. HINGE

IMPACT ENTRANCES

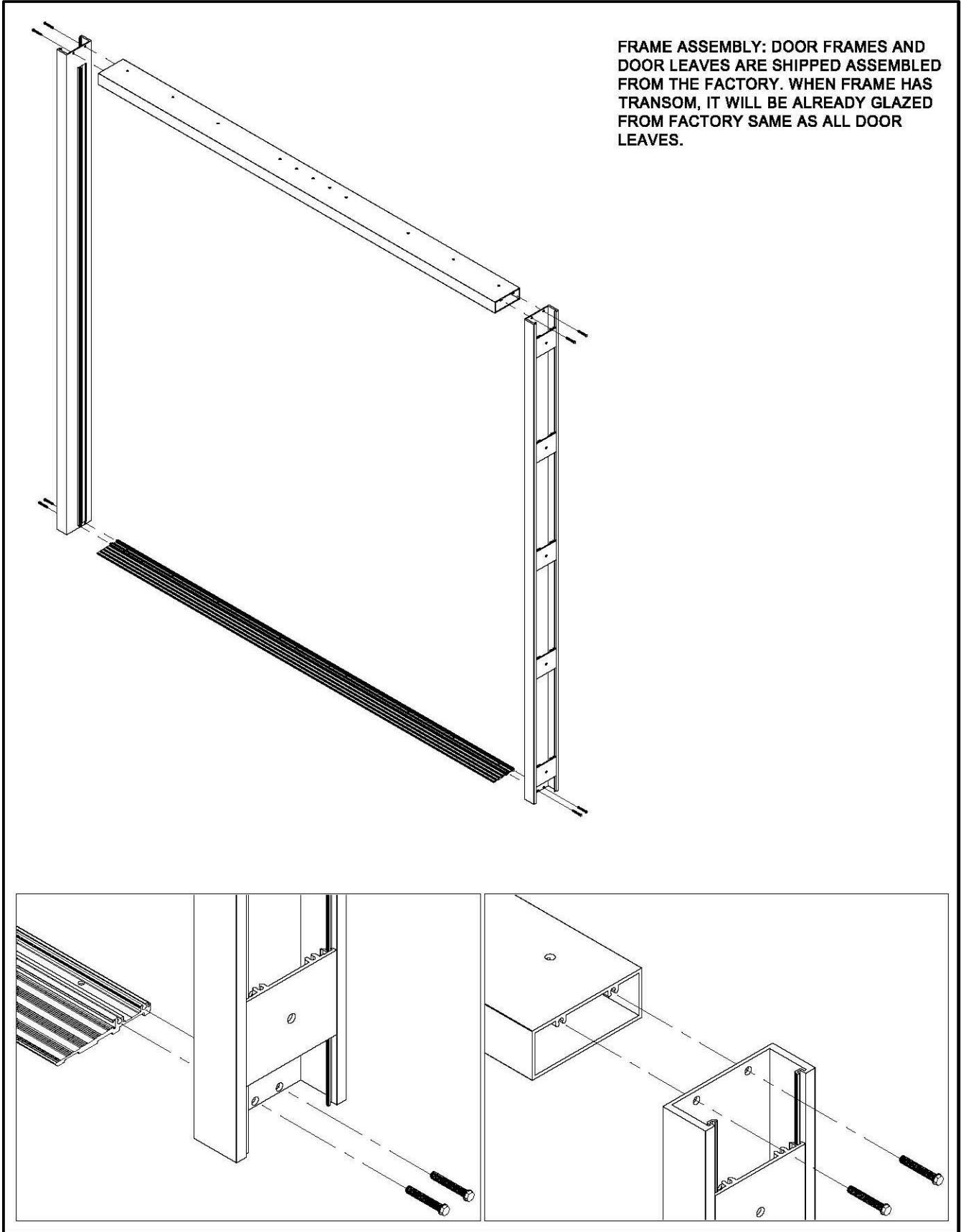

FRAME ASSEMBLY: DOOR FRAMES AND DOOR LEAVES ARE SHIPPED ASSEMBLED FROM THE FACTORY. WHEN FRAME HAS TRANSOM, IT WILL BE ALREADY GLAZED FROM FACTORY SAME AS ALL DOOR LEAVES.

IMPACT ENTRANCES

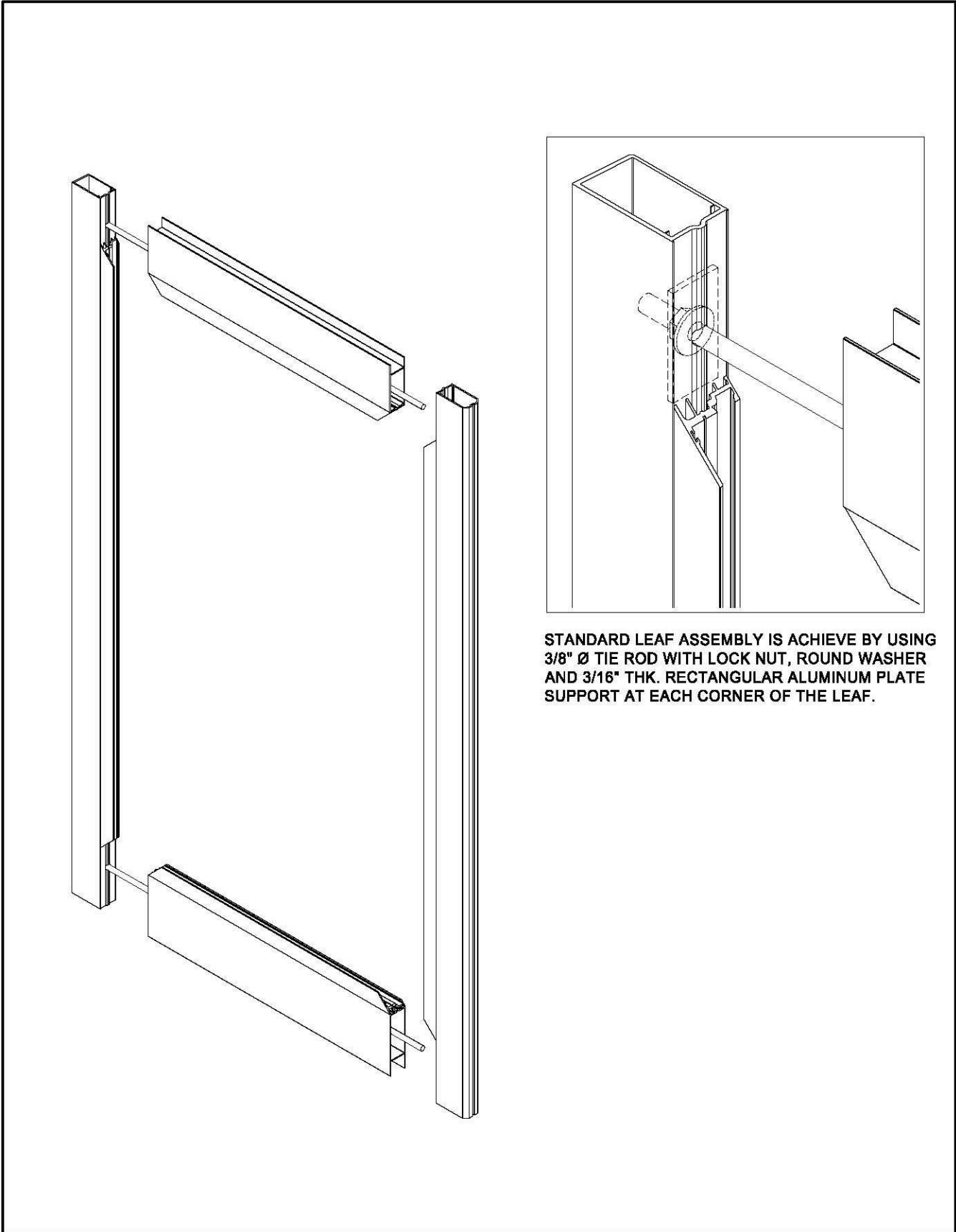

STANDARD LEAF ASSEMBLY IS ACHIEVE BY USING 3/8" Ø TIE ROD WITH LOCK NUT, ROUND WASHER AND 3/16" THK. RECTANGULAR ALUMINUM PLATE SUPPORT AT EACH CORNER OF THE LEAF.

IMPACT ENTRANCES

HEAVY DUTY LEAF ASSEMBLY IS ACHIEVED BY USING THE STANDARD 3/8" Ø TIE ROD ,AND AN ALUMINUM HEAVY DUTY CORNER KEY MECHANICALLY FASTENED AT EA. CORNER OF THE LEAF.

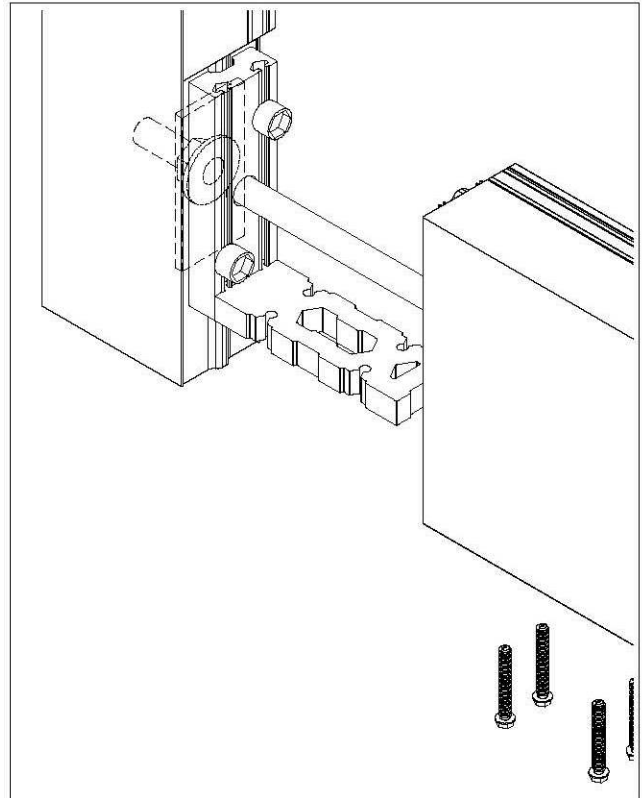
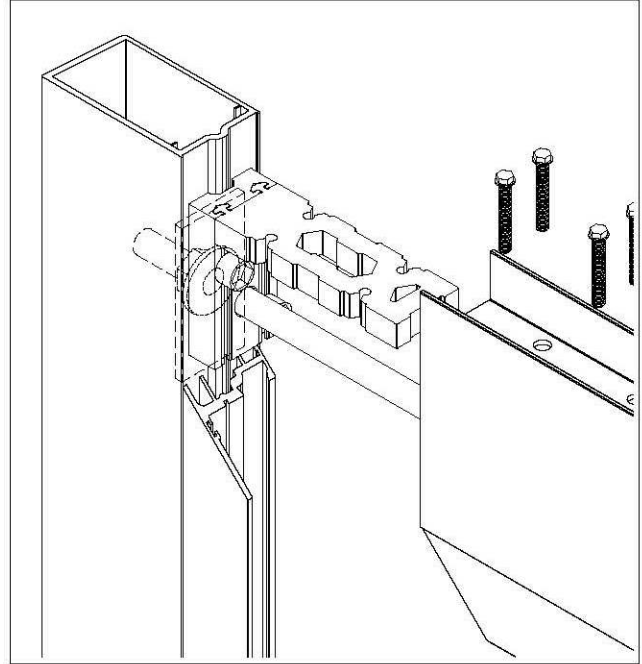
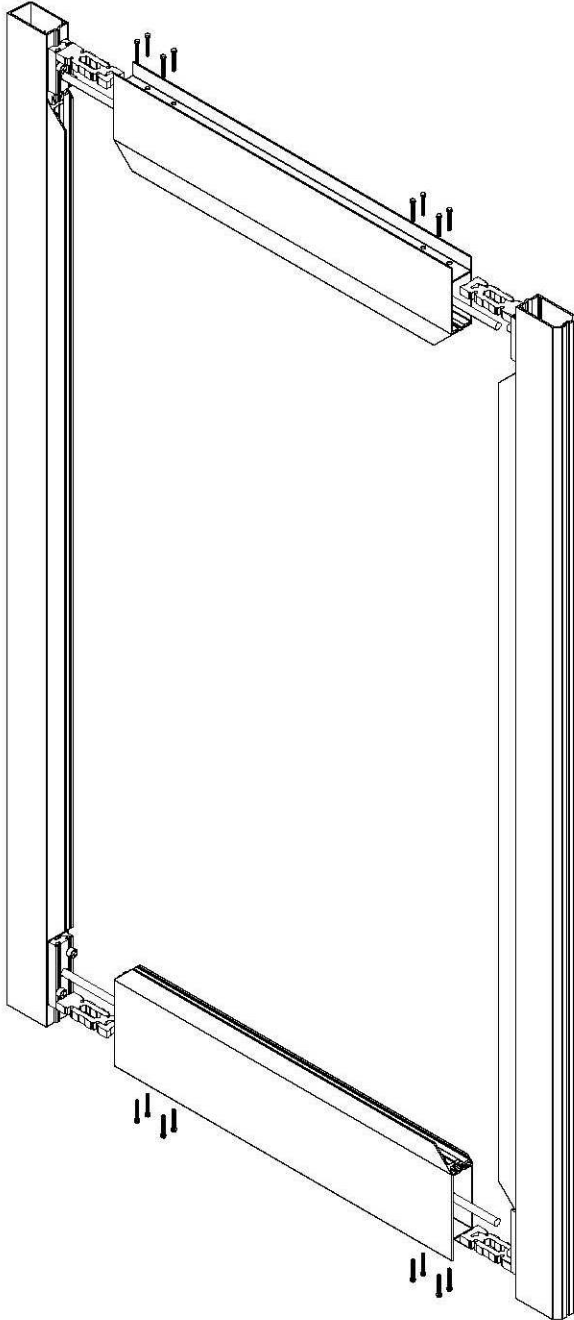

IMPACT ENTRANCES

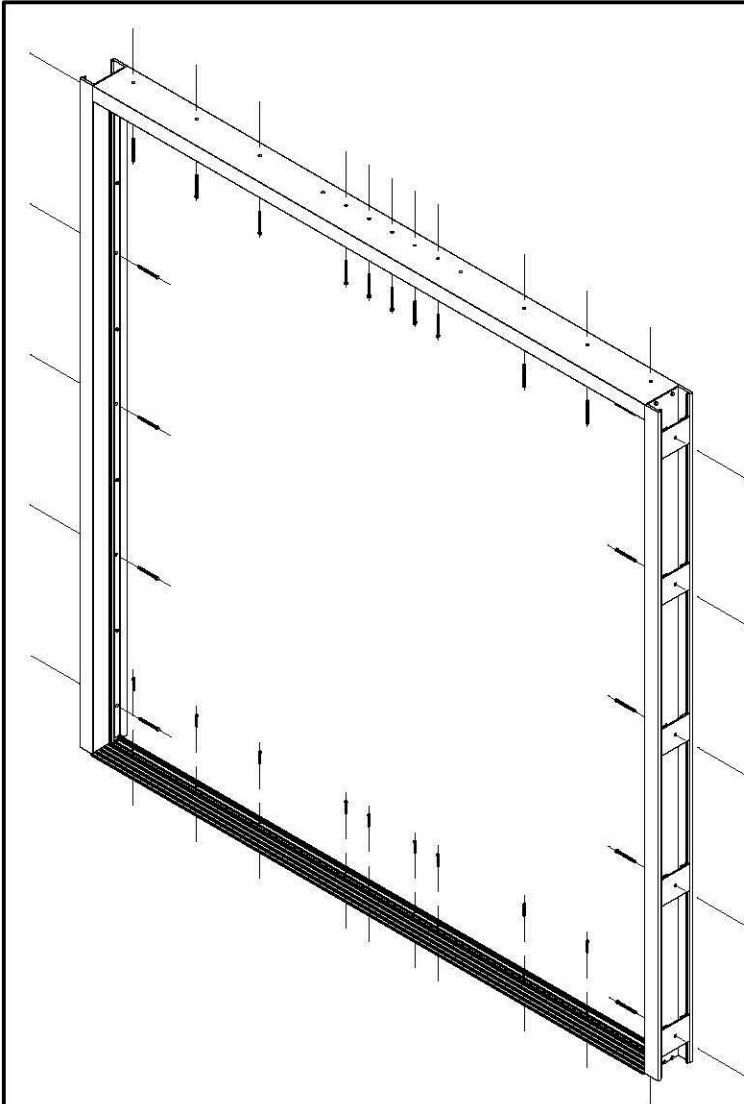

DOOR FRAME INSTALLATION:

PRIOR TO INSTALLING THE DOOR FRAME, MAKE SURE THAT ALL ALUMINUM SURFACES IN CONTACT WITH THE LIME-MORTAR, CONCRETE OR OTHER MASONRY MATERIALS, SHALL BE PROTECTED WITH ALKALI-RESISTANT COATING.

- 1.- RUN A BEAD OF SILICONE UNDERNEATH THE THRESHOLD AT EXTERIOR PART THAT WILL BE SET AGAINST THE FLOOR.
- 2.- SET THE DOOR FRAME INTO THE OPENING, IT MUST BE INSTALLED PLUMB, SQUARE AND LEVEL.
- 3.- SHIM THE SIDES & THE TOP OF THE DOOR FRAME AS REQUIRED TO LEVEL & SECURE IT, LEAVE 1/4" MAX. GAP BETWEEN THE DOOR AND THE SUBSTRATE THIS CREATES THE NECESSARY GAP FOR THE PERIMETER SEALANT TO BE APPLIED.
- 4.- THE INSTALLATION SCREWS ARE FASTENED THROUGH THE DOOR JAMBS, HEAD & THRESHOLD INTO THE SUBSTRATE, THE SCREWS WILL BE COVERED BY THE DOOR STOP COVERS AND THE THRESHOLD COVER.

IMPACT ENTRANCES

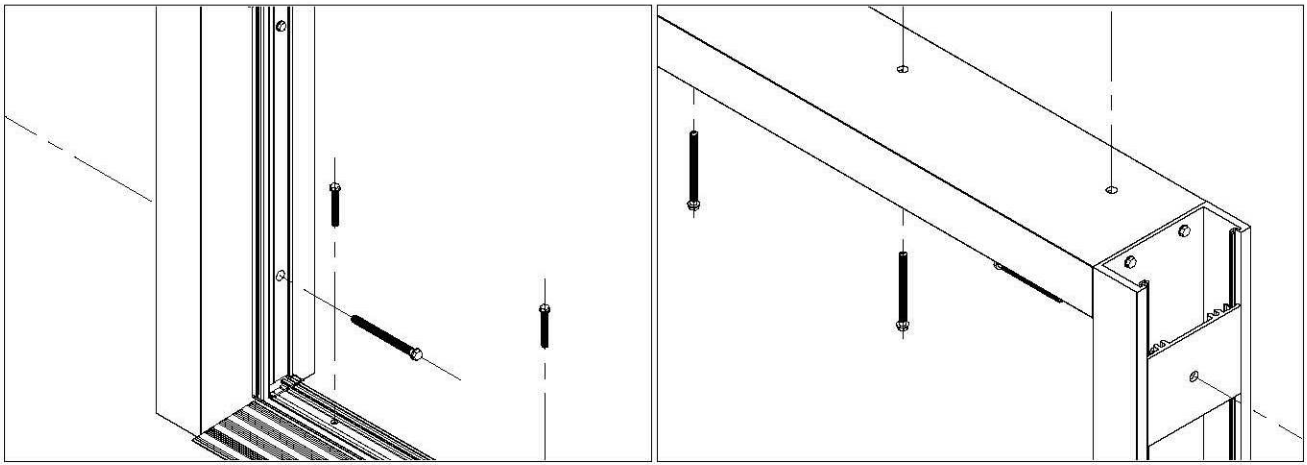

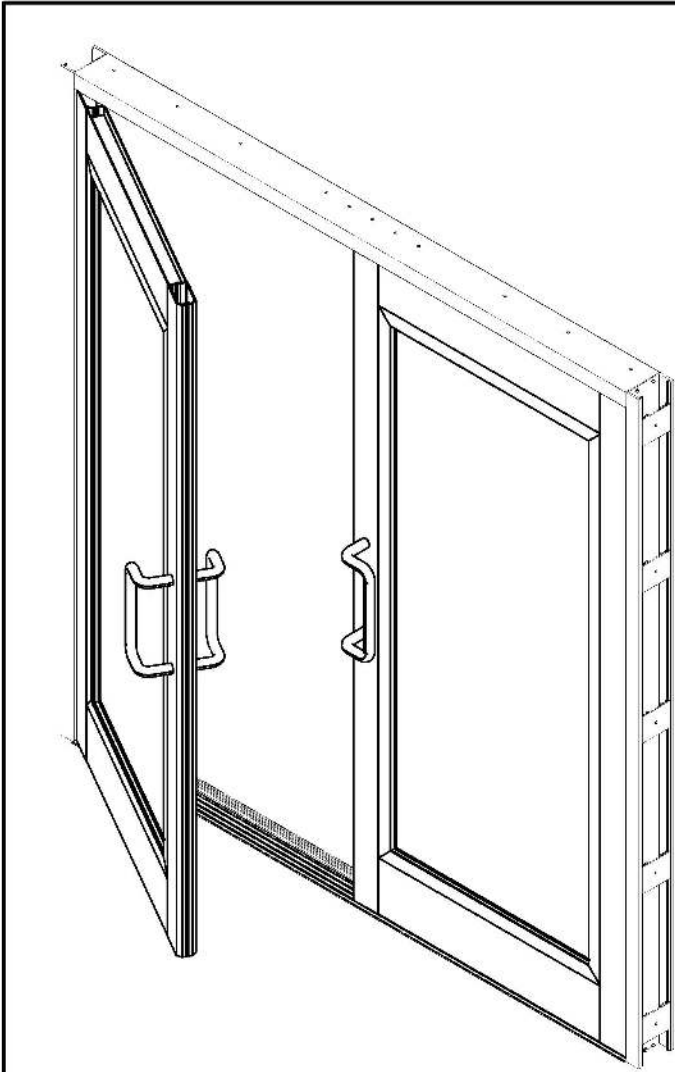

DOOR LEAVES HANGING:
UNLESS OTHERWISE REQUESTED,
ALDORA SHIPS THE DOOR LEAVES WITH
THE HINGES INSTALLED & THE DOOR
FRAMES READY TO RECEIVE THEM.

- 1.- INSTALL DOOR LEAF BY ALIGNING THE HINGES WITH THE DOOR FRAMES BACKING PLATE & FASTEN THEM.
- 2.- MAKE SURE THE LEAF SWINGS FREELY, THE GAP BETWEEN FRAME & LEAF ARE EVEN AND THE LEAF OPENS AND CLOSES WITHOUT INTERFERENCE.
- 3.- ALL LEAVES ACTIVE OR INACTIVE WITH 3 OR 2 POINT LOCK HAVE A YELLOW WARNING STICKER AT INTERIOR BOTTOM OF THEM SAYING THAT BEFORE LOCK THE LEAVES MUST DRILL A 3/8" Ø X 3/4" DEEP HOLE THROUGH THRESHOLD (ALREADY PRE-FAB.) INTO SUBSTRATE.
- 4.- TOOL SILICONE INTO THE NEWLY DRILLED HOLE TO PREVENT WATER FROM SEEPING UNDER THRESHOLD.

